

STOP

CE 0082 UIAA EN 15151-1: 2012 type 5 UK CA

Assisted-braking descender for caving
Descendeur de spéléologie avec freinage assisté

WARNING / ATTENTION

Activities involving the use of this equipment are inherently dangerous. You are responsible for your own actions and decisions.

Before using this equipment, you must:
- Read and understand all Instructions for Use.
- Get specific training in its proper use.
- Become acquainted with its capabilities and limitations.
- Understand and accept the risks involved.

FAILURE TO HEED ANY OF THESE WARNINGS MAY RESULT IN SEVERE INJURY OR DEATH.

Les activités impliquant l'utilisation de cet équipement sont par nature dangereuses. Vous êtes responsable de vos actes, de vos décisions et de votre sécurité.

Avant d'utiliser cet équipement, vous devez :
- Lire et comprendre toutes les instructions d'utilisation.
- Vous former spécifiquement à l'utilisation de cet équipement.
- Vous familiariser avec votre équipement, apprendre à connaître ses performances et ses limites.
- Comprendre et accepter les risques induits.

LE NON-RESPECT D'UN SEUL DE CES AVERTISSEMENTS PEUT ÊTRE LA CAUSE DE BLESSURES GRAVES OU MORTELLES.

PETZL.COM

Latest version Dernière version Other languages Autres langues Technical tips Conseils techniques PPE checking Fiche de contrôle EPI

Warning symbols Panneaux d'alertes (1) (2) (3) (4)

PETZL
FR-38920 Crolles
Cidex 105A
PETZL.COM
ISO 9001
© Petzl

Sustaining our Community
Au service de la Communauté
FONDATION **FONDATION-PETZL.ORG**

Traceability and markings Traçabilité et marquage

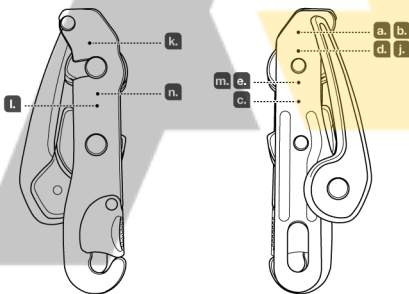

CE a. 0082
APAVE SUDEUROPE SAS
8 rue Jean-Jacques Vernazza
Z.A.C. Saumaty-Séon - CS 60193
13322 Marseille CEDEX 16 France
N°0082

e. Serial number / Numéro de série
YY M 0000000 000
f.
g.
h.
i.

2. Nomenclature

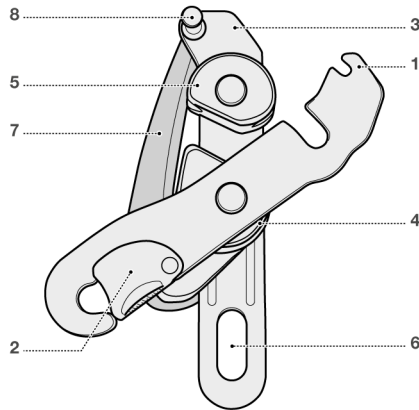

3. Inspection, points to verify Contrôle, points à vérifier



4. Compatibility Compatibilité

EN 1891 8,5 ≤ Ø ≤ 11 mm



5. Function principle and test
Principe et test de fonctionnement

Descent
Descente

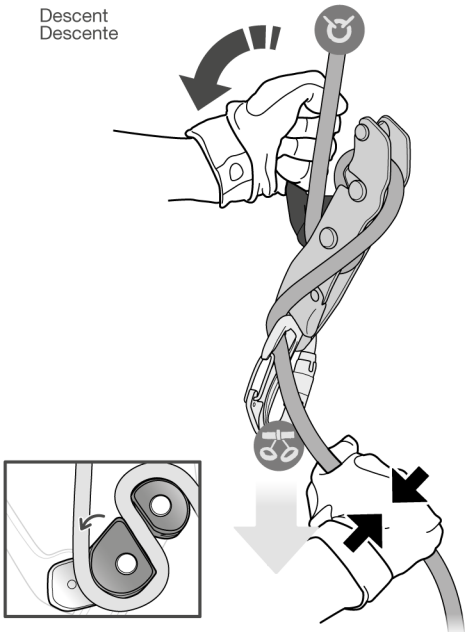

Friction
Freinage

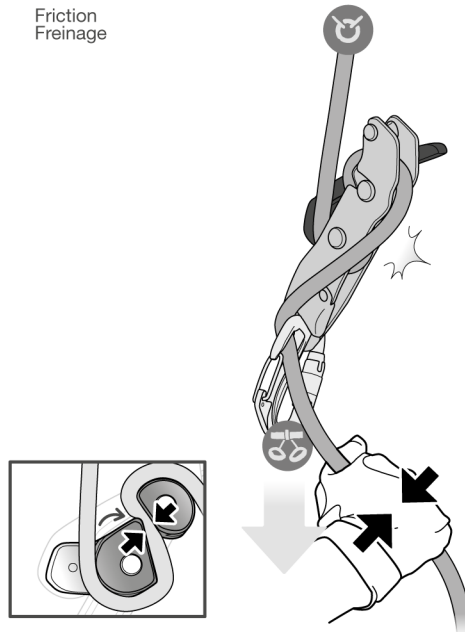

6. Installation

1.

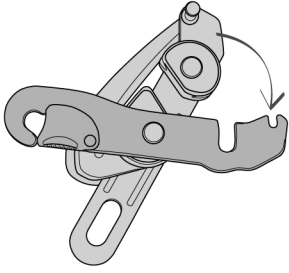

2.

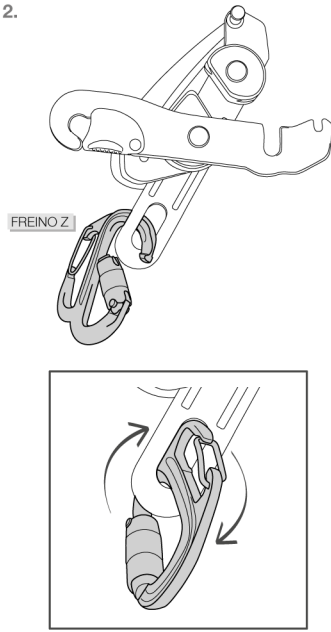

3.

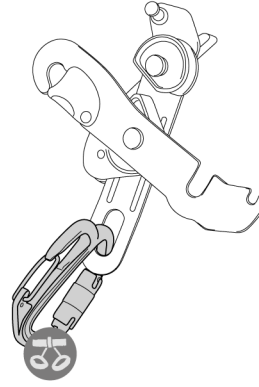

4.

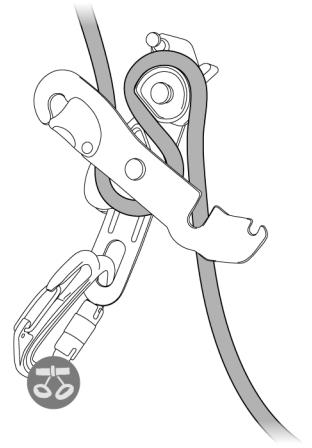

5.

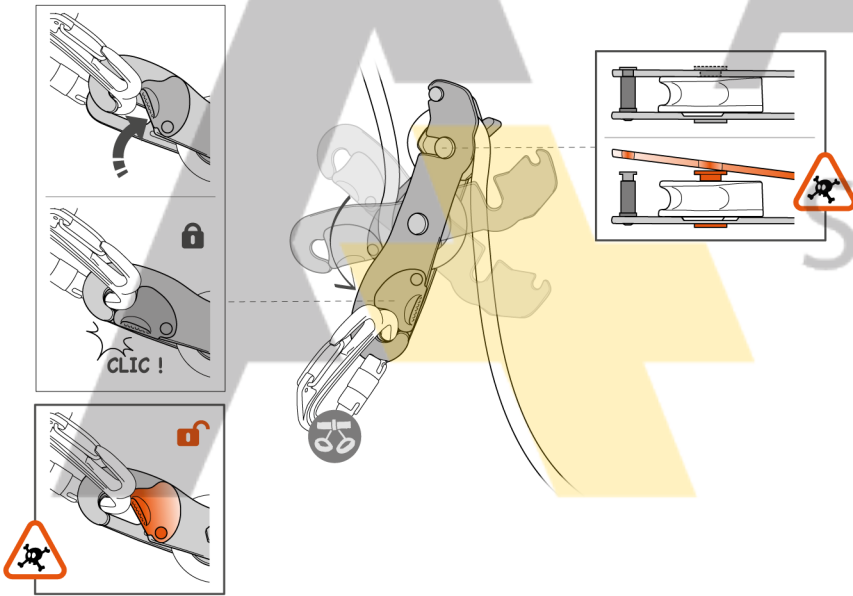

6.

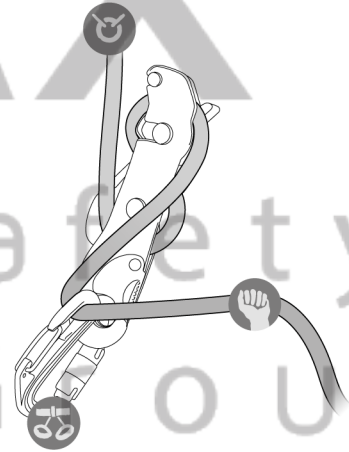

6. Installation

With braking carabiner
Avec mousqueton
de freinage

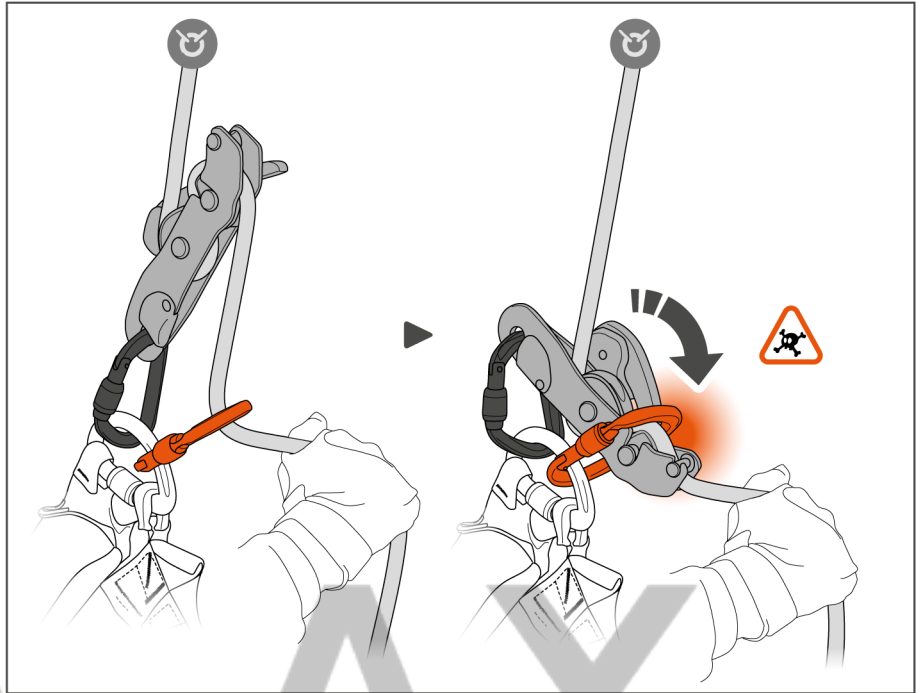
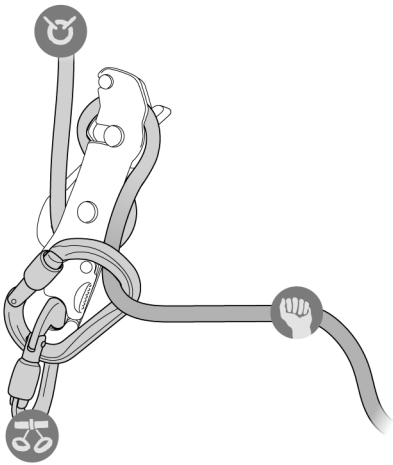

7. Descent

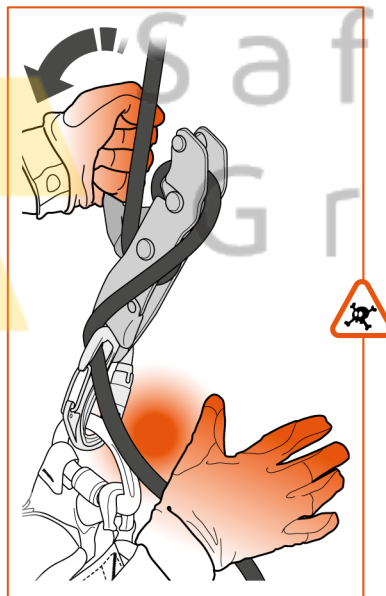
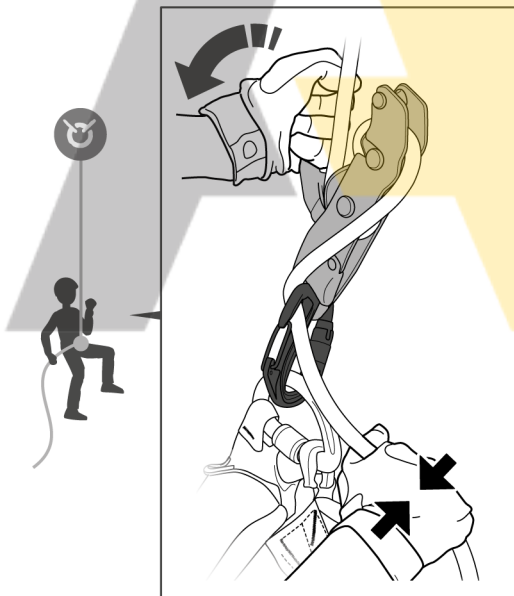

8. Stopping with hands free
Arrêt mains libres

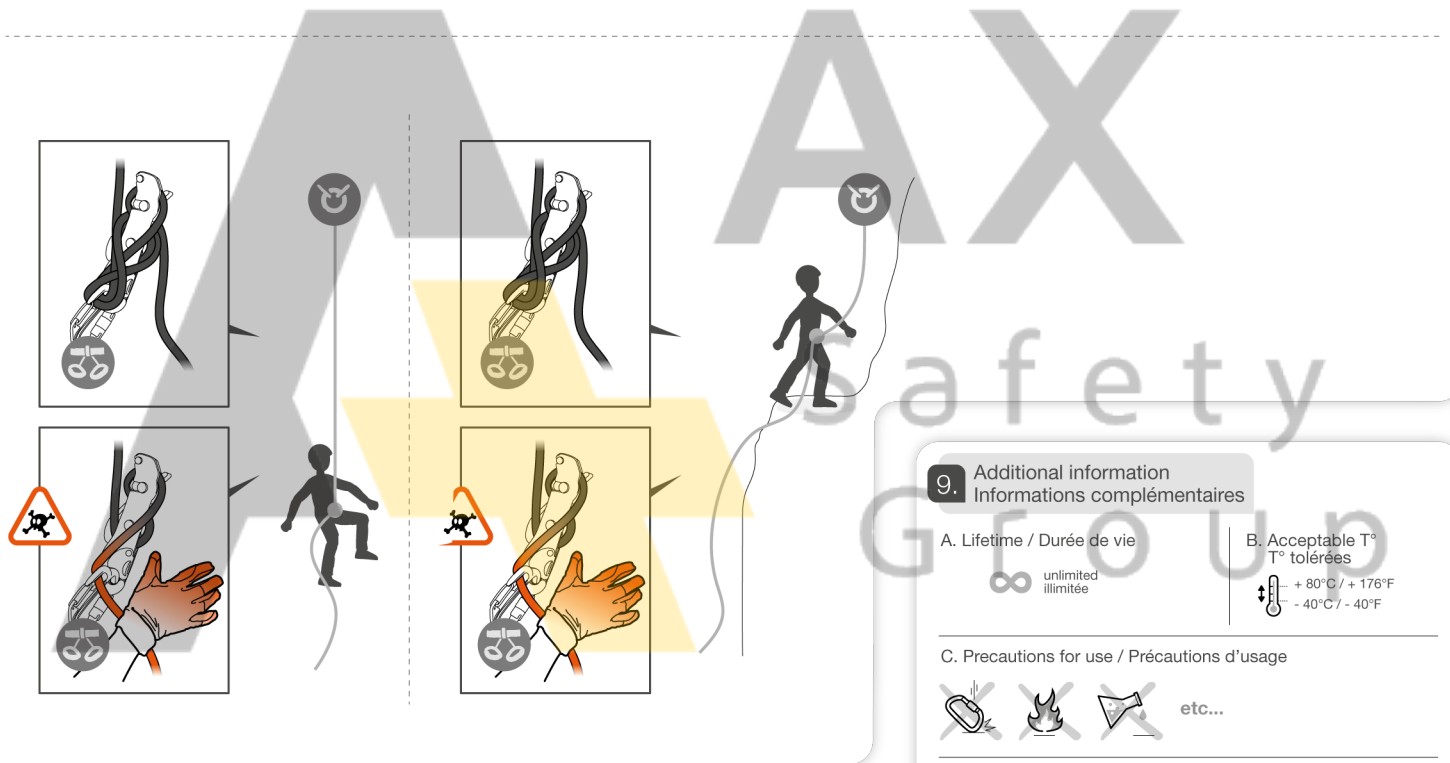
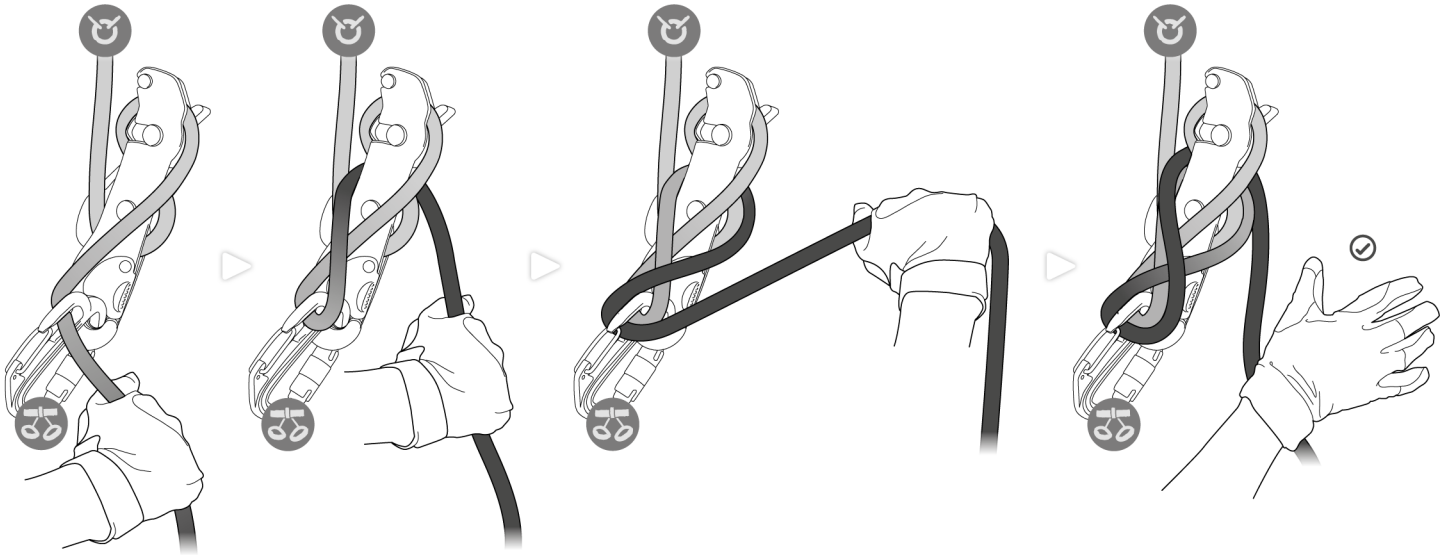

9. Additional information
Informations complémentaires

A. Lifetime / Durée de vie

unlimited
illimitée

B. Acceptable T°
T° tolérées

+ 80°C / + 176°F
- 40°C / - 40°F

C. Precautions for use / Précautions d'usage



D. Cleaning / Nettoyage



E. Drying / Séchage

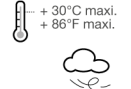

F. Storage - Transport
Stockage - transport



G. Maintenance
Entretien



H. Modifications - Repairs
Modifications - Réparations



I. FAQ - Contact
Questions - Contact

